

RS 100 A

Description

RS is a range of exhaust fans designed for mounting on an outside wall. The casings are manufactured from painted galvanized steel for higher durability.

All fans are fitted with an external rotor induction motor and a backward curved impeller for high performance. Fan speed can be controlled by voltage variation regulators.



Technical data

Parameter	value	Unit
Voltage	230	V
Phase	1	~
Frequency	50	Hz
Power	48	W
Current	0,21	A
R.p.m.	1830	r.p.m.
Max. temperature of transported air	80	°C
Max. temperature of transported air when speed-controlled	80	°C
Sound pressure level at 3 m	56	dB(A)
Length	170	mm
Width	230	mm
Height	252	mm
Enclosure class, motor	44	IP
Insulation class, motor	F	
Capacitor	3	µF
Duct connection	ø100 mm	

Diagrams

○ Selected point

Flow [l/s]
24,5
Stat. pres. [Pa]
134

● Work point

Flow [l/s]
24,5
Stat. pres. [Pa]
134

Power [W]
41,4

Current [A]
0,179

Speed [r.p.m.]
-

Efficiency [%]
7,96

SFP [kW/m³/s]
1,65

Voltage [V]
230

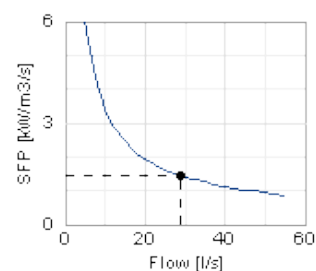
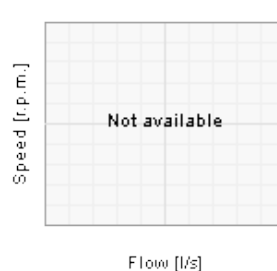
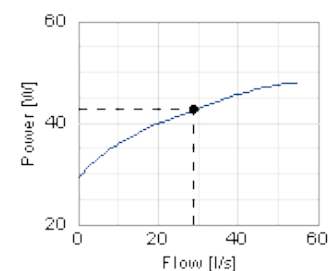
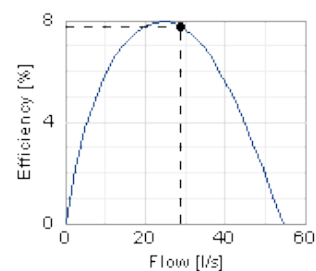
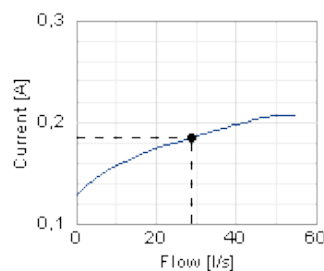
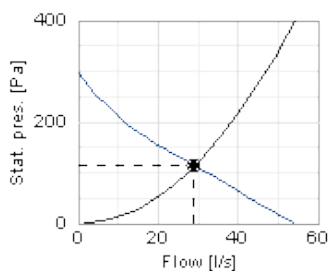

Sound

○ Selected point

Flow [l/s]
29

Stat. pres. [Pa]
114

● Work point

Flow [l/s]
29

Stat. pres. [Pa]
114

Total press. [Pa]
122

Power [W]
42,7

Current [A]
0,185

Speed [r.p.m.]
-

Efficiency [%]
7,76

SFP [kW/m³/s]
1,44

Voltage [V]
230

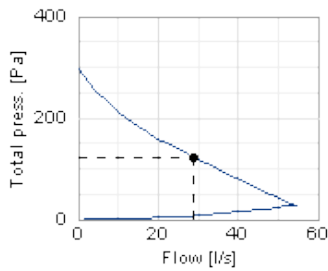
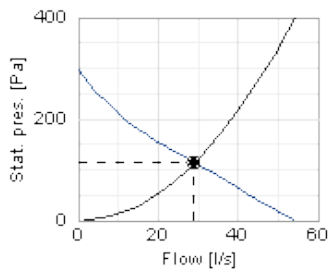

Distance: 3

Propagation type: Semi-spherical

Equivalent absorption area: 20

	Tot	63	125	250	500	1k	2k	4k	8k
Inlet Lw dB(A)	69	60	60	62	62	61	56	50	44
Surrounding Lw dB(A)	64	29	38	50	57	61	56	51	42
Surrounding Lp dB(A)	57	23	31	43	51	54	50	44	36

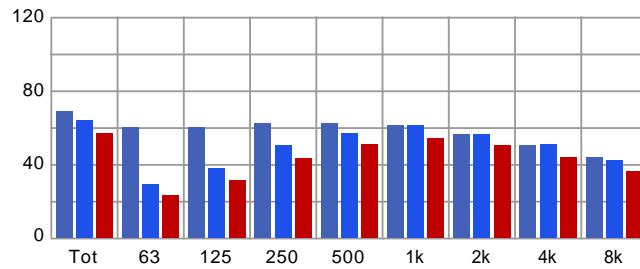

Dimensions

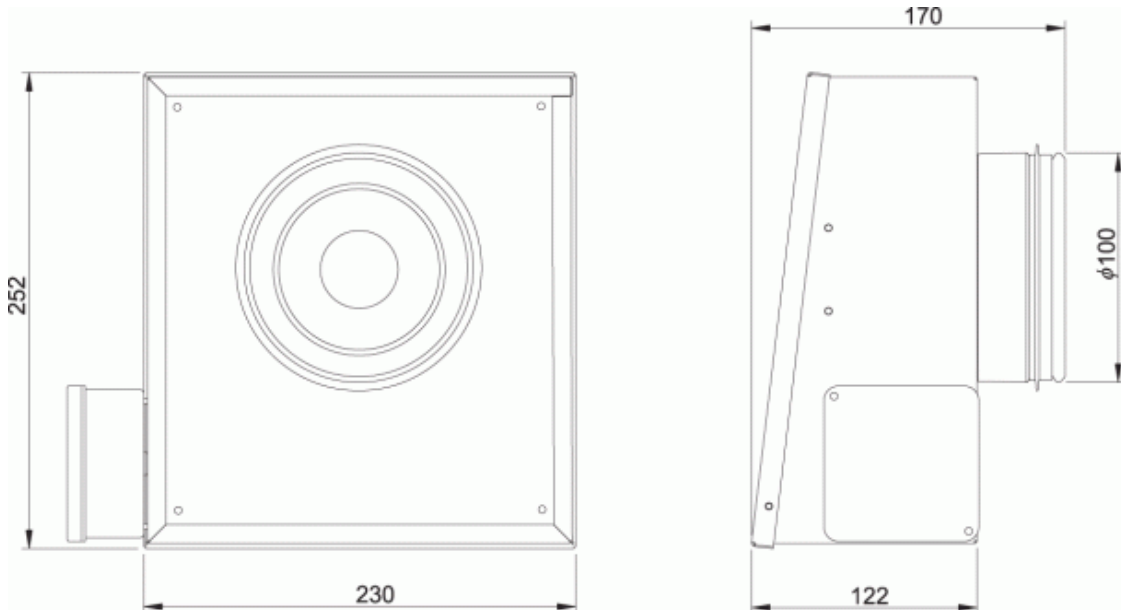

Wiring diagram

4040002

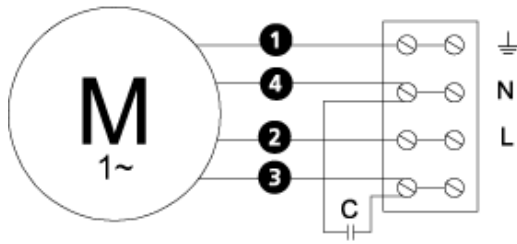

- Ⓜ = Fan Motor
- Ⓜ1 = Fan Motor
- Ⓜ2 = Fan Motor
- Ⓜ3 = Rotor Motor
- ① = Yellow/Green
- ② = Black
- ③ = Blue
- ④ = Brown
- ⑤ = White (TW)
- ⑥ = Orange
- ⑦ = Grey
- ⑧ = Red
- ⑨ = Green
- ⑩ = Violet

Accessories

Electric accessories



ETFBV-94A



FRE 6



VRDE 1,5



VRS 0,5



VRTEC

Accessories



LDC 100